

Fixed Frequency Synthesizer Surface Mount Module

Applications

- Broadband Transmission
- Optical Transmitter
-

Application Notes

- AN-107: Manual Soldering Technique
- AN-205: Measuring Phase Noise for SFS Series

Performance Specifications

	Min	Typ	Max	Units
Frequency	9900		9900	MHz
Phase Noise @ 10 kHz offset (1 Hz BW)		-83		dBc/Hz
Harmonic Suppression (2nd)		-30		dBc
Spurious Suppression		-70		dBc
Power Output	-3	0	3	dBm
Load Impedance		50		Ω
Settling Time		3		mS
Operating Temperature Range	-30		75	$^{\circ}\text{C}$
Package Style		SFS-L1		

Power Supply Requirements

	Min	Typ	Max	Units
Supply Voltage 1: PLL (Vcc, nom)		3		Vdc
Supply Voltage 2: VCO (Vcc, nom)		5		Vdc
Supply Current 1: PLL (Icc, typ)		11		mA
Supply Current 2: VCO (Icc, typ)		90		mA

Reference Oscillator Signal

	Min	Typ	Max	Units
Frequency		10		MHz
Phase Noise @1 kHz Offset		-145		dBc/Hz

Additional Notes

LFSuffix = RoHS Compliant. All specifications are subject to change without notice.

© Z-Communications, Inc. All Rights Reserved.

14118 Stowe Drive, Suite B | Poway, CA 92064 | TEL: (858) 621-2700 | FAX: (858) 486-1927

URL: www.zcomm.com | EMAIL: applications@zcomm.com

Phase Noise, typ.

Footprint

PHASE NOISE (1 Hz BW, typical)

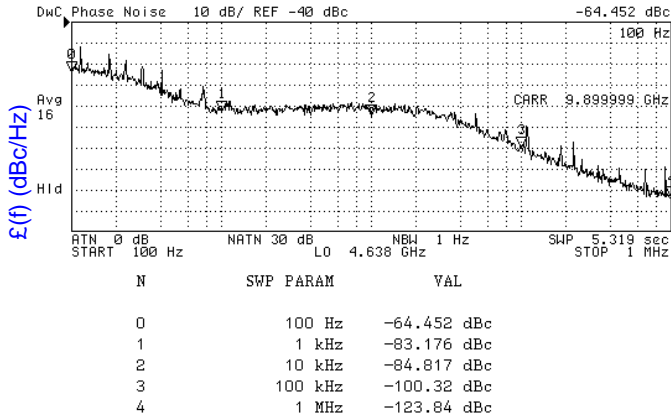

RECOMMENDED FOOTPRINT

SEVERAL HOLES OF \varnothing 0.015 ON GND. PLANE ARE RECOMMENDED FOR GOOD GROUNDING.

0.030 MIN. CUTBACK FROM LIVE PADS

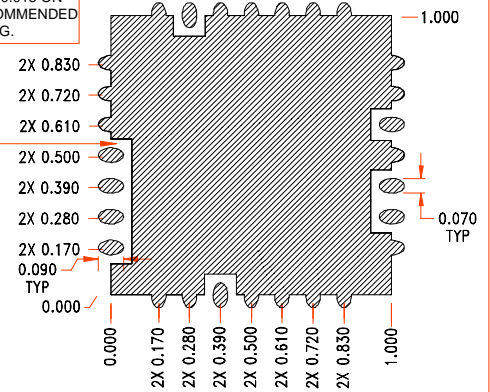

OFFSET (Hz)

Physical Dimensions

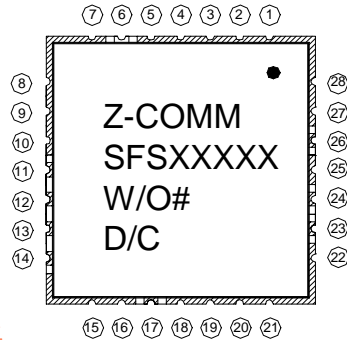
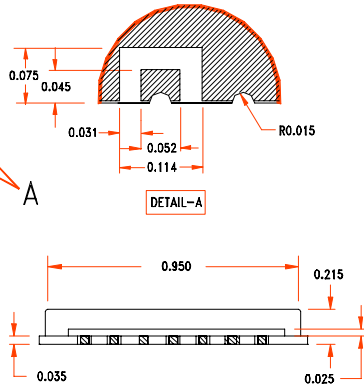
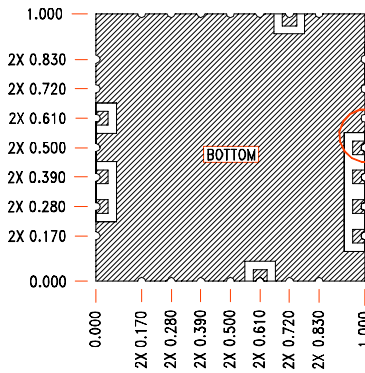

PIN CONFIGURATION

6	RF OUT
11	LOCK DETECT
12	N/C
13	N/C
14	N/C
17	REF IN
23	N/C
24	Vcc CHIP
26	Vcc VCO
REST	GROUND

NOTE: ALL DIMENSIONS ARE IN INCHES
TOL: XXX: +/- 0.010