

14118 Stowe Drive, Suite B  
 Poway, CA 92064  
 TEL: (858) 621-2700 | FAX: (858) 486-1927  
 URL: www.zcomm.com  
 EMAIL: applications@zcomm.com

## Voltage-Controlled Oscillator Surface Mount Module

### Applications

- Satellite Communication Systems
- Upconverter/Downconverter
- 

### Application Notes

- AN-101: Mounting and Grounding
- AN-102: Output Loading
- AN-107: Manual Soldering

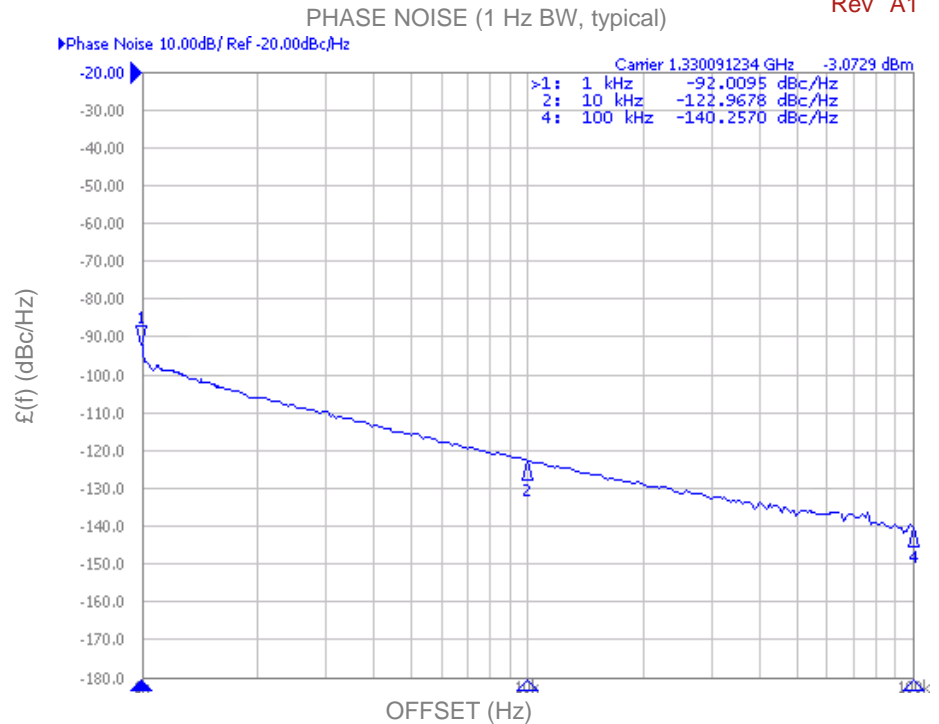

Performance Specifications	Min	Typ	Max	Units
Oscillation Frequency Range	1330		1330	MHz
Phase Noise @ 10 kHz offset (1 Hz BW)		-118		dBc/Hz
Harmonic Suppression (2nd)		-20	-18	dBc
Tuning Voltage	0		5	Vdc
Tuning Sensitivity (avg.)		3		MHz/V
Power Output	0	3	6	dBm
Load Impedance		50		$\Omega$
Input Capacitance			50	pF
Pushing			.5	MHz/V
Pulling (12 dB Return Loss, Any Phase)			.5	MHz
Operating Temperature Range	0		50	$^{\circ}\text{C}$
Package Style	MINI-16-SM			

Power Supply Requirements	Min	Typ	Max	Units
Supply Voltage (Vcc, nom.)		5		Vdc
Supply Current (Icc)		29	35	mA

### Additional Notes

Tuning Curve, typ.

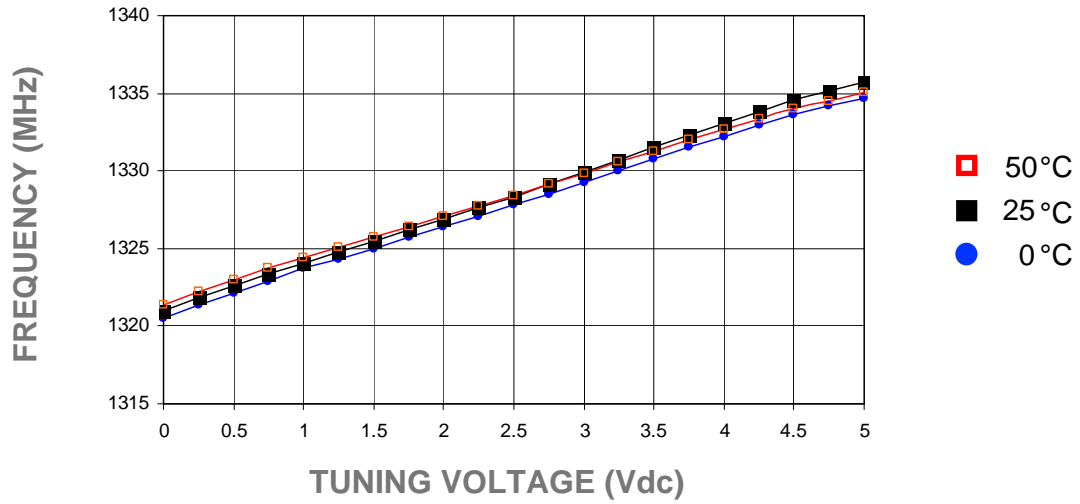

Power Curve, typ.

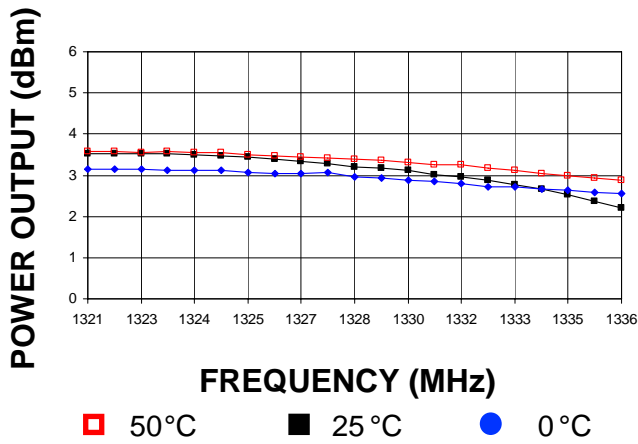

Footprint

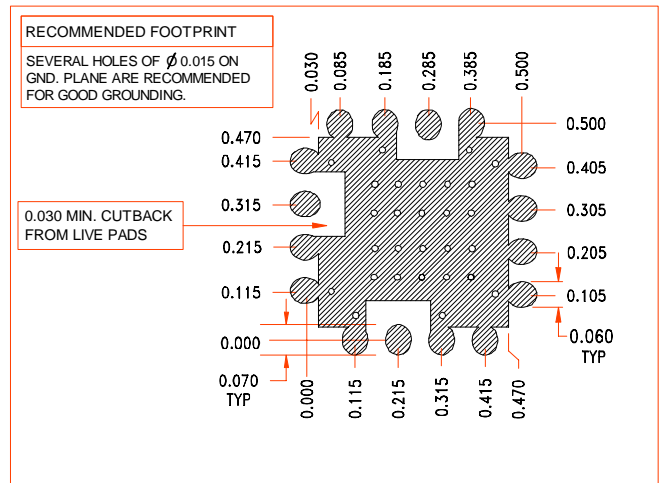

Physical Dimensions



LFSuffix = RoHS Compliant. All specifications are subject to change without notice.