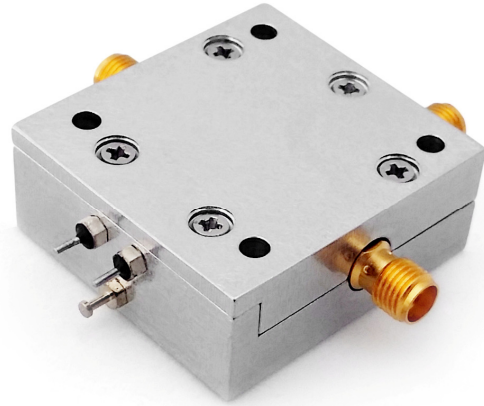
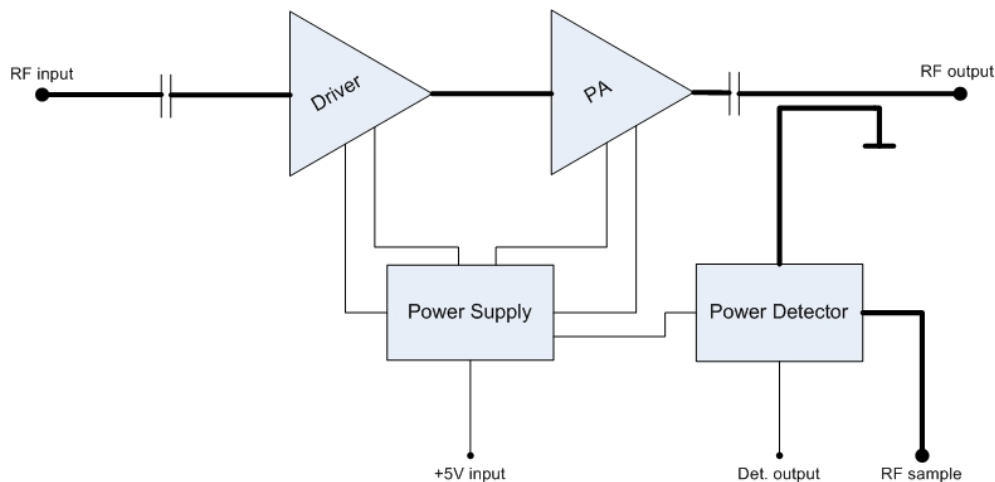

Application

Point to Point Radio
SATCOM

Features

- Frequency range: 17.7 ~ 19.7 GHz
- Power: 30 dBm sat
- Gain: 26 dB
- OIP3: 46dBm at 23dBm/tone
- Single +5V power supply
- Wide range power detector 30 dB
- RF sample output -17 dB
- 1.4x1.5x0.6 inch package
- RF connectors: SMA

***Functional Block Diagram******General Description***

The PAC18700T is a K-band Power amplifier module with integrated power supply and detector circuit providing more than 30dBm output power from 17.7 to 19.7 GHz frequency band. This high gain power amplifier has a typical 26dB gain over its frequency range. With high third order intercept point of 46 dBm, PAC18700T is one the best options for applications where linearity is important. The integrated single +5V power supply and wide dynamic range power detector and modular configuration with SMA connectors for input, output and sample make this amplifier easy to use in any system on this band.

Absolute Maximum Rating

Parameter	Rating
Power supply	6 V
RF input power	20 dBm
Storage temperature	-40 to 150 °C
Operational body temperature	-40 to 65 °C

Specifications

Parameter	Condition	Min	Typ	Max	Unit
Frequency		17.7		19.7	GHz
Gain			26		dB
Vd			5		V
Id		1.4	1.5	2	A
Pout	1dB		29		dBm
Pout	Saturation		30		dBm
Input RL		10			dB
Output RL		10			dB
Isolation			50		dB
OIP3	23dBm/tone		46		dBm
NF		5		8	dB
Detector	0 to 30 dBm	0		3	V
Temperature		-40		55	°C

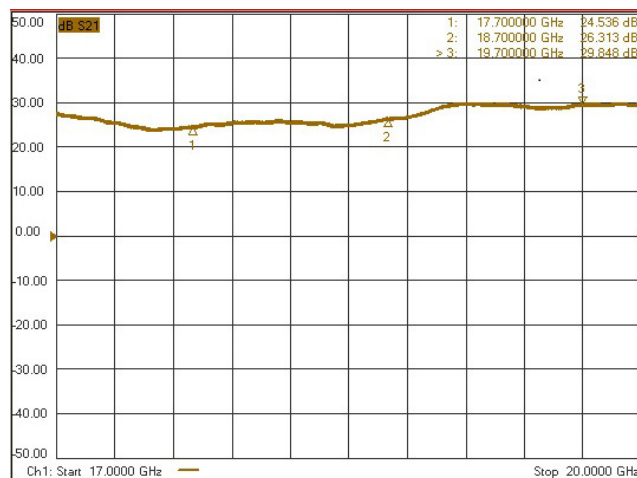
Typical Performance Graphs

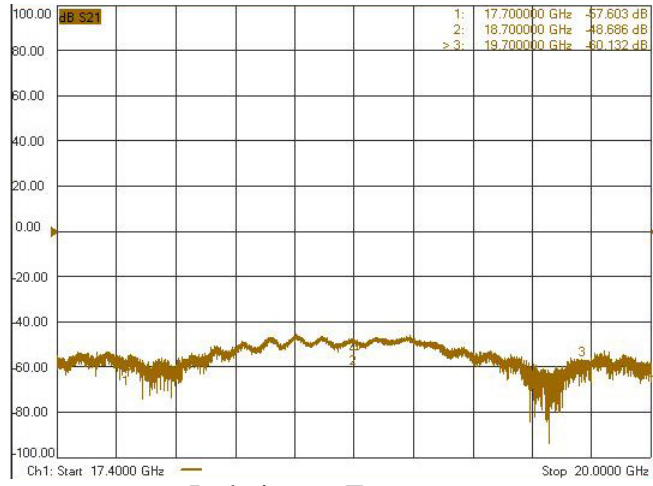
Gain vs Frequency

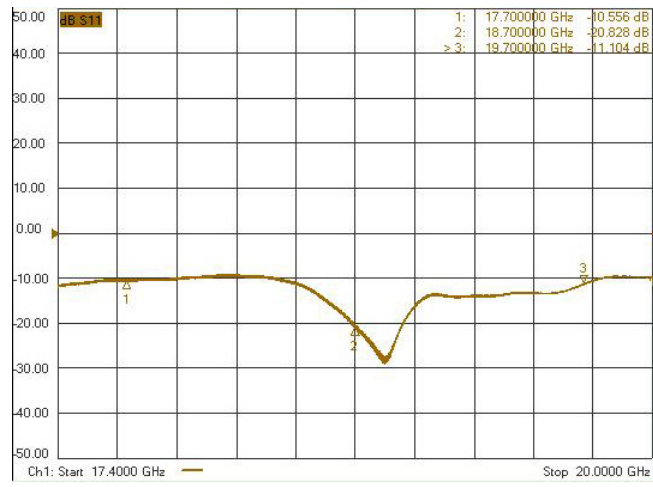

Isolation vs Frequency

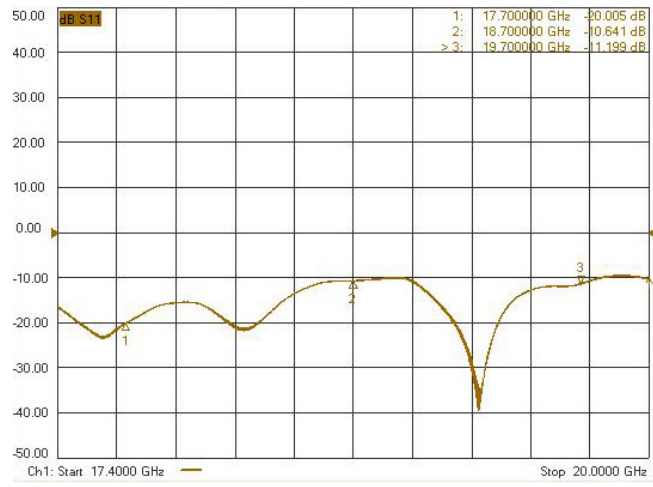

Input Return Loss vs Frequency



Output Return Loss vs Frequency

Dimension

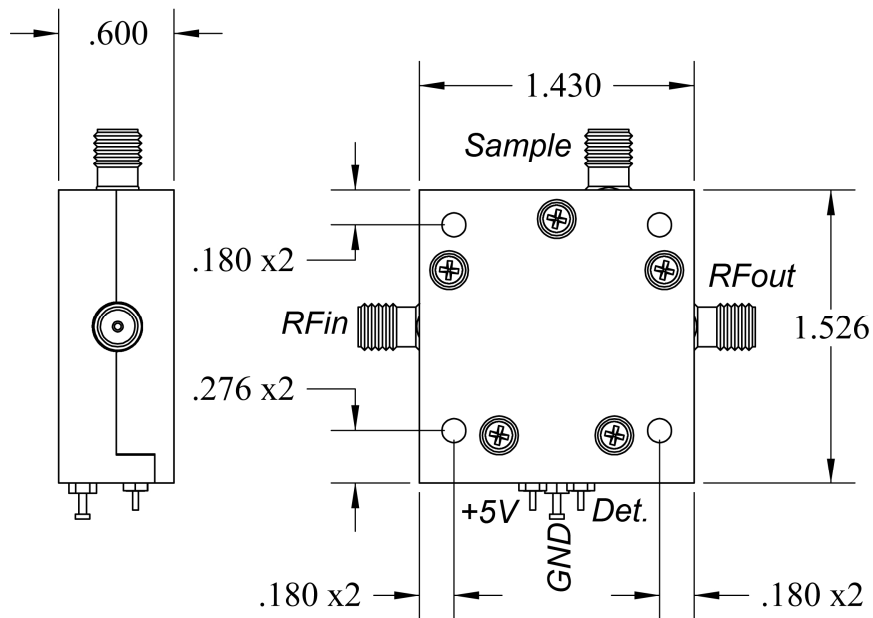

Custom Design

The Gain, Sample power and Detector voltage level can be customized. To order a customized module, please contact ZComm.